

Date

---



---

Name

---



---

Client

---



---

Project name

---



---

Quote#

---



---

Type/Quantity

---



---



---



---



---



---



---



---

22/05/2019 22:59:15

### CARREE ST OK S1

202 50 51

[Enlace web](#)

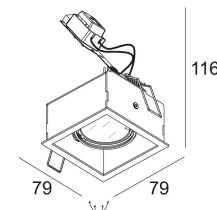

Forma cortada/tamaño:	75 x 75 mm
Profundidad de empotrado:	80 mm
Grosor de la superficie de montaje:	max.35
Colores disponibles:	ALU GRIS (202 50 51 A) BLANCO (202 50 51 W)
ADJUSTABLE 0-20°	
GX5.3 // 12V // EXCL.TRANSFO	
1 x QR-C51 max.50W	
Clase:	III
Peso:	0.3 KG
Nivel de protección:	IP20
Distancia mínima:	0,5m
Observaciones:	WHITE finish : max. 35W
Opciones:	PLASTERKIT 161 CONCRETE BOX 161 MOUNTING KIT 75 TRANSFO
Accesorios:	ANTI GLARE TUBE DICROIC FILTER 50

Para obtener instrucciones detalladas de instalación, consulte el manual. [202\\_50\\_51\\_HAND.pdf](#)

**CARREE ST OK S1**  
202 50 51

**Compatibilidad con techos**

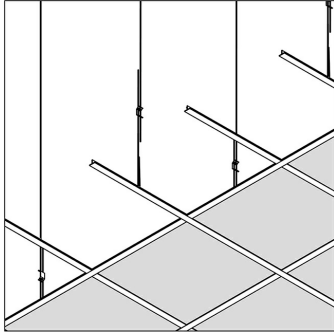

**Sistema de techos**

**Opcional**

MOUNTING KIT 75

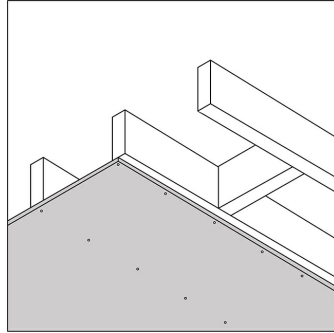

**Techo falso**

**Opcional**

MOUNTING KIT 75

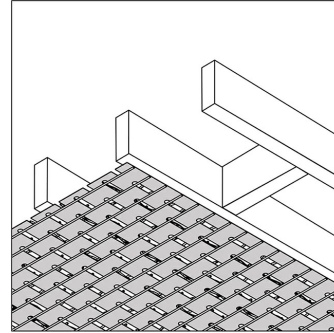

**Stucanet**

**Opcional**

PLASTERKIT 161

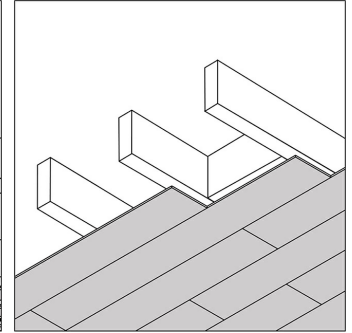

**Madera**

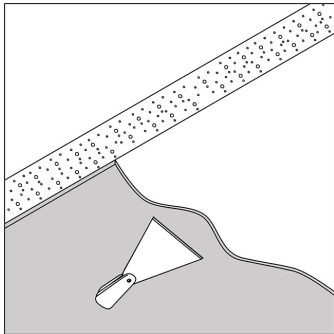

**Concreto + yeso**

**Solo con**

PLASTERKIT 161  
CONCRETE BOX 161

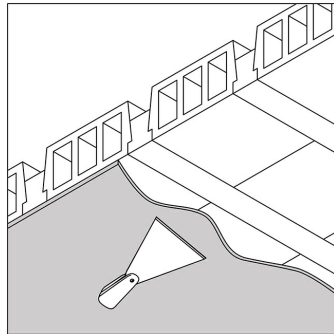

**Stalton + yeso**

**Solo con**

PLASTERKIT 161  
CONCRETE BOX 161

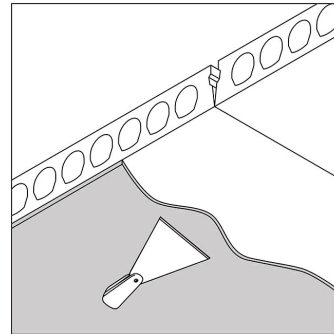

**Boveda + yeso**

**Solo con**

PLASTERKIT 161  
CONCRETE BOX 161

**CARREE ST OK S1**  
202 50 51

Referencias relacionadas

**EQUIPO DE ENCENDIDO, BALASTROS Y TRANSFORMADORES**

Enlace web, Ficha de especificaciones

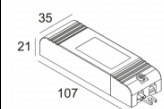

TRANSFO 100W  
200 46 10  
220-240V / 50-60Hz

Enlace web, Ficha de especificaciones

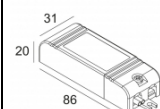

TRANSFO 50W  
200 46 06  
220-240V / 50-60Hz

Referencias relacionadas

**KITS DE YESO**

[Enlace web](#) , [Ficha de especificaciones](#)

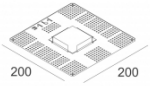

PLASTERKIT 161  
207 01 161

Referencias relacionadas  
**CAJA PARA CONCRETO**

[Enlace web](#) , [Ficha de especificaciones](#)

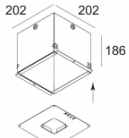

CONCRETE BOX 161  
270 11 161

Referencias relacionadas  
**MOUNTING KIT**

[Enlace web](#) , [Ficha de especificaciones](#)

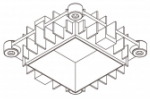

MOUNTING KIT 75  
202 00 75

Referencias relacionadas  
**DISPOSITIVOS DE MODIFICACIÓN DE LUZ**

[Enlace web](#) , [Ficha de especificaciones](#)

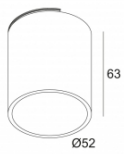

ANTI-GLARE TUBE  
201 34 00

CARREE ST OK S1  
202 50 51

Imagen del proyecto

